

錐套式時規皮帶輪 L型
 TAPER BUSH TIMING PULLEYS <L>

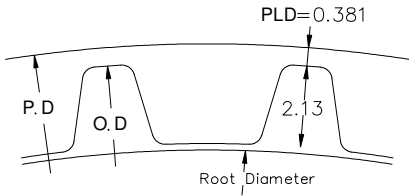

Type	Material	Treatment	Flange	Treatment	Taper Bush	Treatment
KLAAA	A7075	Anodize	A6061	Anodize	1045	—
KLAEA		Electroless nickel		Electroless nickel		
KLS	1045	—	1045	—		
KLSS	SUS308		A6061	Anodize	SUS308	

Tooth Shape :



Pulley Shapes : E

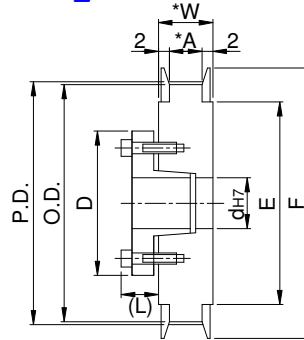

F

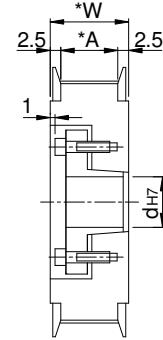

Type	Catalog No.			Bore dh7	P.D	O.D	F	E		
	No.of teeth	Teeth Width Code	Pulley Shapes							
KLAAA KLAEA KLS KLSS	14	L015 A:15 W:20	E	8~12	42.45	41.68	48	35		
	15			8~12	45.48	44.72				
	16			10~17	48.51	47.75	55	40		
	17			10~17	51.54	50.78				
	18			10~17	54.57	53.81	61	45		
	19			12~17	57.61	56.84				
	20			L022	F	12~17	60.64	59.88	67	50
	21			A:22		12~25	63.67	62.91		
	22			W:27		12~25	66.7	65.94	80	60
	24			L027 A:27 W:32		12~30	72.77	72		
	25	12~32	75.8			75.04				
	26	12~32	78.83			78.07				
	28	12~35	84.89			84.13				
	30	L040 A:40 W:45	F	12~42		90.96	90.2	99	80	
	32			12~42	97.02	96.26	104	84		
	34			12~42	103.08	102.32	111	90		
	36			12~42	109.15	108.39	123	102		
	38			12~42	115.21	114.45	127	105		
	40			12~42	121.28	120.51	131	110		

Order TYPE — Catalog No. — Bore
 訂貨代號 KLAA — 36L015E — 15

PS1 : if you need another exceptional to process the specifications form, please contact us.

PS2 : Taper Bush Specification Please refer to 【Taper Bush Specification Form】



Taper Bush Specification Form

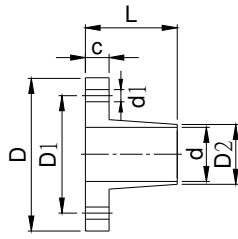

3 pcs tight fixed type
d dimension is 10~12

4 pcs tight fixed type
d dimension is 8,14~25

6 pcs tight fixed type
d dimension is 28~50

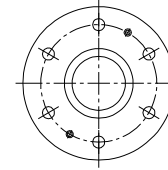
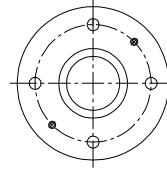
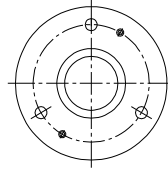

Material: S45C

Bore d	Tightening Bolt		Tapped Hole of Removal	Allowable maximum Torque N · m {kgf · m}	Allowable Thrust Load kN {kgf}	Bolt Tightening Torque N · m {kgf · m}	D	D1	D2	d1	L	1					
	number	size															
8	4	M3×12	M3×2	16 { 1.6 }	4.0 { 408 }	2.0 { 0.21 }	25.5	19	10	3.3	15.5	4					
10	3	M4×16	M4×2	39 { 4.0 }	5.34 { 545 }	4.0 { 0.41 }	30	22	12	4.5	16.5	5					
11				43 { 4.4 }			31	23	13								
12				48 { 4.9 }			32	24	14								
14	4	M4×18	M4×2	73 { 7.4 }	8.74 { 895 }	8.3 { 0.85 }	35	27	16.6	5.5	22	6					
15				78 { 7.95 }			36	28	17.6								
16				83 { 8.5 }			37	29	18.6								
17		88 { 9.0 }	38	30			19.6										
18		154 { 15.7 }	43	33			20.6	23	7								
19		163 { 16.6 }	45	35			22.4										
20		171 { 17.4 }	46	36			23.4										
22	6	M5×20	M5×2	186 { 19.16 }	12.3 { 1260 }	13.7 { 1.4 }	48	38	24.6	6.6	24	8					
24				206 { 21.0 }			50	40	26.6								
25				216 { 21.8 }			52	42	28.4								
28				353 { 36.0 }			54	44	30.6								
30				382 { 39.0 }			57	47	33.4								
32		412 { 42.0 }	59	49			34.7	25	9								
35		451 { 46.0 }	63	53			38.4										
38		M6×28	M6×2	686 { 70.0 }			22.7 { 2320 }	34.3 { 3.5 }	70				58	42	8.8	38.5	13
40				725 { 74.0 }					71				59	43.5			
42				757 { 77.2 }					74				62	46			
45	M8×35	M8×2	1490 { 152.0 }	1600 { 163.0 }	1660 { 169.0 }	84	69	49.5	8.8	38.5	13						
48			1600 { 163.0 }			87	72	52.5									
50			1660 { 169.0 }			89	74	54.5									

▲Features of Taper Bush Timing Pulleys

No need to machine key grooves , etc . On shafts.

Shaft strenght can be kept , as no shaft machining is required.

No backlash & Easy positioning.

▲Installation

- 1 Wipe off dirt from the surface of shaft and apply a thin coat of oil or grease to it. (Do not use any oil or grease containing molybdenum-based lubricant)
- 2 Clean the contact surfaces of pulley and bushing and apply oil or grease to them. Apply oil or grease to the threads and bearing surface of fastening bolt as well.
- 3 Install pulley temporarily on shaft with fastening bolts lightly tightened.
- 4 After completion of locating , tighten the clamping bolts using the torque wrench in the diagonal line order , beginning lightly (about one-fourths of the predetermined tightening torque)
- 5 Increase the tightening to about half of the predetermined value , and tighten the bolts.
- 6 Continue the tightening until the predetermined tightening torque is reached.
- 7 Finally , tightening the clamping bolts along the circumference of the circle.

▲Note

Use torque wrench in tightening the bolt.

Do not use bolts other than those attached for tightening bolts.

▲Removal

Be sure to work after the system is completely shut down.

Loosen the tightening bolt in circumferential order.

Insert bolt in tapped holes for removal and tighten evenly.

Repeat "Installation" process for reinstallation.